

AC Input 2-Channel Tunable White LED Modules with Tri-Mode Dimming™ (TRIAC, ELV & 0-10 V)

Input Voltage	Max. Source Lumens	Typ. Input Power	CCT Range	CRI	Dimming Method	Dimming Range
120 - 277 Vac	3000 lm	32 W	2750 - 5000 K	90+	TRIAC, ELV, & 0-10 V	1-100%



CWM2 (with Diffuser Lens)

Light Emitting Surface: 32 mm
Diameter: 65 mm (2.56 in)
Height: 20.5 mm (0.81 in)

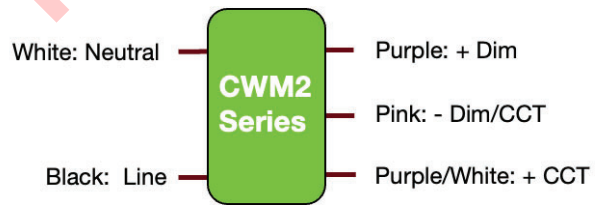
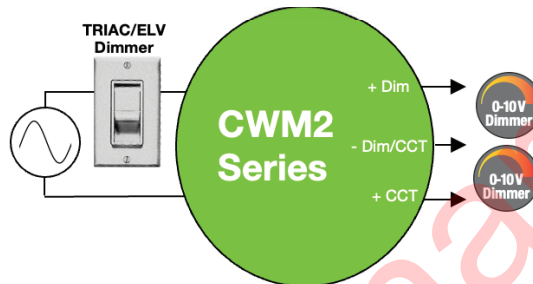

Wiring Diagram

KEY FEATURES

- Integrated AC to DC driver electronics
- 2 modes of operation: Tunable white, Static White
- Designed for field replaceability
- Approved for use as thermal cutout for fixture per UL1598
- Configure Light output with Max-Trim
- CA Title 24, IEEE 1789-2015, & Energy Star Compliant
- Color consistency of < 3 step (2 step typical) MacAdam ellipse
- Available with or without Diffuser Options
- Available with or without Bluetooth Options
- Dim-to-off capability (when used with 0-10 V dimmer)
- Bluetooth LE commissioning with the ERP Tunable White app (iOS)
- Front heat sink mounting
- On board thermal foldback

APPLICATIONS

- Inventory Control
- Downlights
- General Illumination



ERP Tunable White iOS App



AC Input 2-Channel Tunable White LED Modules with Tri-Mode Dimming™ (TRIAC, ELV & 0-10 V)

1 - ORDERING INFORMATION

1.1 CWM2 - Tunable White LED Modules

CWM2-AA-LL-FO
1
2
3
4

1 - Light Emitting Surface	
Value	Meaning
32	32 mm

2 - Typical Source Lumens	
Value	Meaning
30	3000 lm

3 - Feature Tier	
Value	Meaning
E	Enhanced
P	Premium

4 - Optic Choice	
Value	Meaning
D	Diffuser
N	No Diffuser

1.2 Feature Sets

Value	Feature				
	Static White	0-10 V Tunable White Control	Tri-mode Dimming	0-10 V Dim-To-Off	Bluetooth LE (BLE) Commissioning
E	✓	✓	✓	✓	
P	✓	✓	✓	✓	✓

AC Input 2-Channel Tunable White LED Modules with Tri-Mode Dimming™ (TRIAC, ELV & 0-10 V)

1.3 AC Input Power Cables (Ordered Separately)

Description	Part Number
2-wire AC Input Power Cable Assembly for CWM2, Black/White, 400 mm, for North America	AC-CWM2-NA
2-wire AC Input Power Cable Assembly for CWM2, Black/White, 100 mm, for North America	AC-CWM2-NA-100
2-wire AC Input Power Cable Assembly for CWM2, Black/White, 413 mm, with quick disconnect, for North America	AC-CWM2-NAQD
2-wire AC Input Power Cable Assembly, Black/White, 400 mm, with quick disconnect and flying leads, for North America	AC-NAQD-FL

1.4 DC Output Control Cables (Ordered Separately)

Description	Part Number
3-wire DC Output Control Cable Assembly for CWM2, Pink/Violet/Violet-White, 400 mm, for North America	DC-CWM2-NA

Note: See Section-4 for more details on the power and control cable assemblies for CWM2.

1.5 Accessories (Ordered Separately)

Description	Part Number
CWM Programming Tool with CWM2 Programming Cable	PROG-CWM2
CWM2 Programming Cable	PROG-CWM2-CBL
Reflector Holder for LEDiL Reflectors	HLDR-CWM2-LEDIL
Reflector Holder for Nata Reflectors	HLDR-CWM2-NATA

AC Input 2-Channel Tunable White LED Modules with Tri-Mode Dimming™ (TRIAC, ELV & 0-10 V)

2 - OPERATIONAL SPECIFICATIONS

2.1 Electrical Specifications (@ 25 °C Ambient Temperature)

Specification	Units	Minimum	Typical	Maximum	Notes
Input Voltage Range	Vac	90	120, 277	305	-
Input Frequency Range	Hz	47	50/60	63	
Input Current	mA	-	-	320 mA @ 120 Vac 160 mA @ 277 Vac	
Power Factor		0.9	> 0.9		At nominal input voltage and 100% output
Total Harmonic Distortion (THD)	%	-	-	20 %	At nominal input voltage, and from 100% to 40% of rated lumen output
Inrush Current	A	Meets NEMA-410 requirements			At any point on the sine wave and 25 °C
Leakage Current	mA	-	-	0.32 mA @ 120 Vac 0.75 mA @ 277 Vac	Measured per IEC60950-1
Input Harmonics	Complies with IEC 61000-3-2 for Class C equipment				
Standby Power	mW	-	-	500 mW @ 120 Vac 1000 mW @ 277 Vac	During Dim-to-Off mode
Start Time	ms	-	≤ 300	500	± 25 ms

AC Input 2-Channel Tunable White LED Modules with Tri-Mode Dimming™ (TRIAC, ELV & 0-10 V)

2 - OPERATIONAL SPECIFICATIONS

2.2 Photometric Specifications (@ 60 °C Substrate Temperature, T_s)

Specification	Range	Notes
Lumens	≤ 3000 lm	Listed light output and efficacy refers to light output from the source. Diffuser lenses and additional optics will affect final light output and efficacy. See page 6 for characterization charts.
Efficacy (LPW)	95 lm/W	
CCT (Tunable Range)	2750-5000 K	
CRI (Ra)	90+	2750–5000 K
CRI (R9)	70+	2750–5000 K
Lumen Maintenance	L70 (70% of initial lumens) at 50,000 hours.	
Flicker	Compliant with IEEE 1789-2015.	

AC Input 2-Channel Tunable White LED Modules with Tri-Mode Dimming™ (TRIAC, ELV & 0-10 V)

2 - OPERATIONAL SPECIFICATIONS

2.3 Lumen and Color Performance Data

Typ. Lumen Output at Various CCT Points

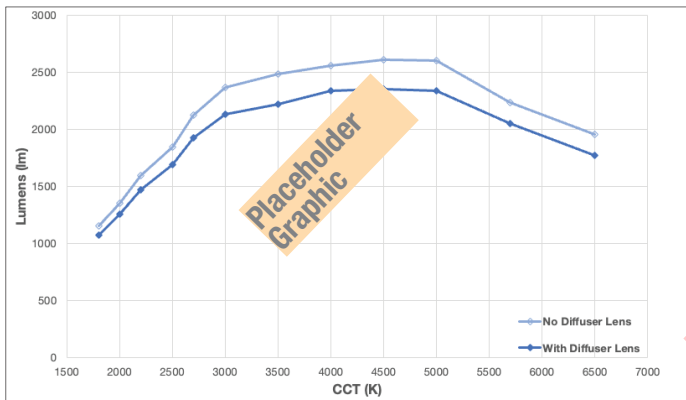

Typ. Efficacy (LPW) at Various CCT Points

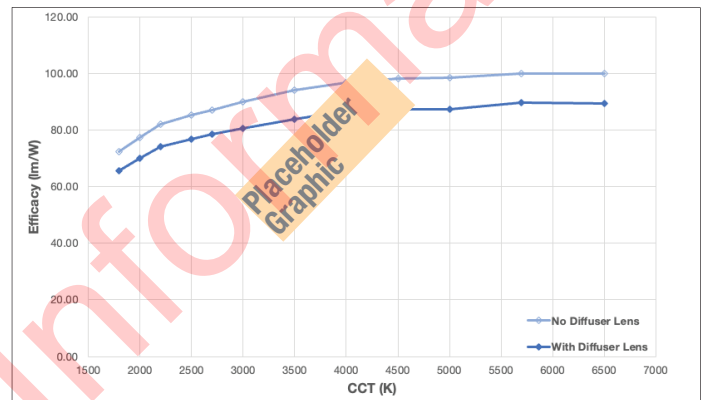

Spectral Power Data (SPD) at Various CCT Settings

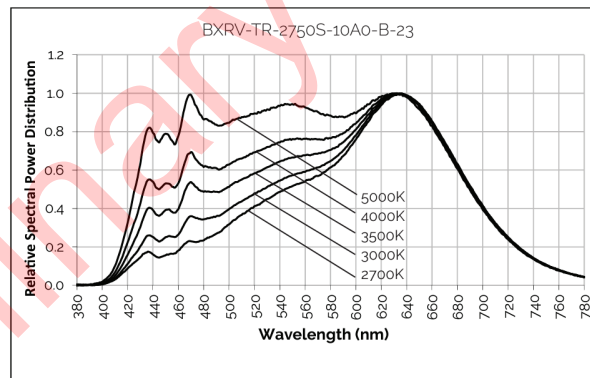

CRI (Ra and R9) at Various CCT Points

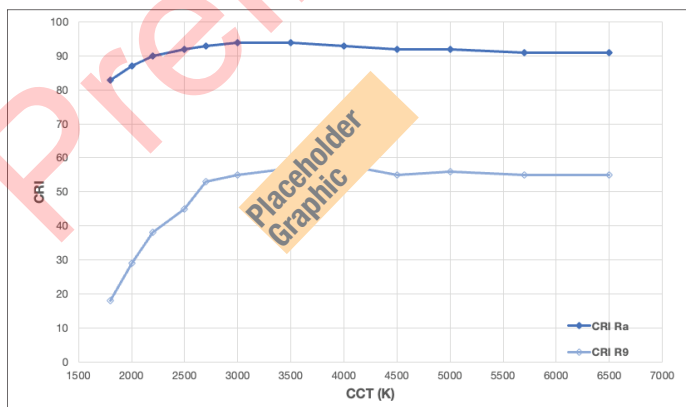

12 Selectable CCT Points in the CIE 1931 Color Space

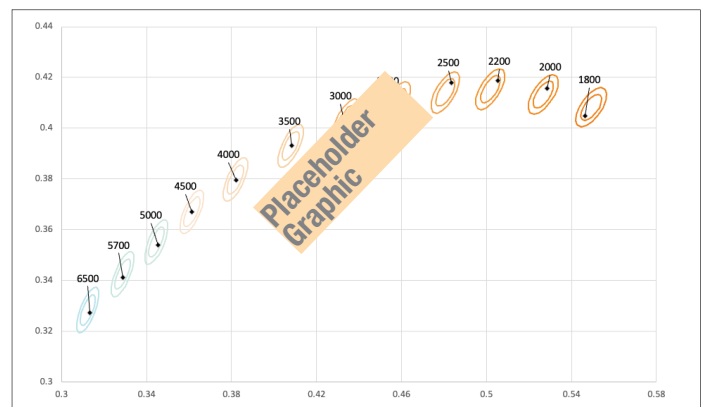

AC Input 2-Channel Tunable White LED Modules with Tri-Mode Dimming™ (TRIAC, ELV & 0-10 V)

2 - OPERATIONAL SPECIFICATIONS

2.4 Environmental and Safety Specifications

Specification	Units	Minimum	Maximum	Notes
Operating Ambient Temperature (Ta)	°C	-20	40	
Maximum Case Temperature (Tc)	°C	-	90	
Maximum Substrate Temperature (Ts)	°C	-	95	
Storage Temperature	°C	-40	85	
Humidity	%	5	95	Non-condensing.
Acoustic Noise	dBA	-	24	Measured at a distance of 1 foot (30 cm): both forward and reverse phase AC phase-cut dimmers.

Specification	Notes
Mechanical Shock Protection	As per EN60068-2-27.
Vibration Protection	As per EN60068-2-6 & EN60068-2-64.
MTBF	> 200,000 hours when operated at nominal input conditions, and at $T_c < 90$ °C.
Driver Lifetime	50,000 hours at $T_c = 90$ °C maximum case hot spot temperature.
Conducted & Radiated EMI	Compliant with FCC CFR Title 47 Part 15 Class B at 120 Vac, Class A at 277 Vac.

Specification	Type	Standard	Notes
Harmonic Current Emissions	-	IEC 61000-3-2	For Class C equipment.
Immunity Compliance	ESD (Electrostatic Discharge)	IEC 61000-4-2	6 kV contact discharge, 8 kV air discharge, level 3.
	Electrical Fast Transient	IEC 61000-4-4	2 kV on AC power port for 1 minute, 1 kV on signal/control lines.
	Surge	IEC 61000-4-5	2 kV line to line (differential mode) / 1.5 kV line to common mode ground.
		ANSI/IEEE c62.41.1-2002 & c62.41.2-2002 category A, 2.5 kV ring wave.	
High Pot or Dielectric Voltage Withstand		2200 Vdc	Tested between 0–10 V leads and AC input.

Safety Agency	Notes
UL	UL recognized component
NEMA	SSL-1-2016
CA Title 24	Compliant
ENERGY STAR®	Compliant

AC Input 2-Channel Tunable White LED Modules with Tri-Mode Dimming™ (TRIAC, ELV & 0-10 V)

2 - OPERATIONAL SPECIFICATIONS

2.5 Commissioning Protocols

Protocol	Dimming	CCT	Notes
0-10 V (CCT)	-	2750-5000 K	Operational CCT range can be adjusted/customized via the ERP Tunable White iOS app.
0-10 V (DIM)	100-1%	-	<ol style="list-style-type: none"> Option to set Dim-Trim using the ERP Tunable White iOS app or the CWM Programming Tool. Option to set Dim-Trim and/or to enable Dim-to-Off using the ERP Tunable White iOS app or the CWM Programming Tool*.
TRIAC			
ELV			
BLUETOOTH LE (ERP Tunable White iOS app)	100-1%	2750-5000 K	<p>Use for commissioning, not for control.</p> <ol style="list-style-type: none"> Adjust maximum output level (set Dim-Trim between 100% and 40%). Enable Dim-to-Off. Customize the CCT range for Tunable White mode. "Set and forget" the CCT for Selectable White Mode.
CWM Programming Tool	-	-	<ol style="list-style-type: none"> Adjust the maximum output level (set Dim-Trim) - FULL, 80%, 60%, 40%. Enable Dim-To-Off. Disable Bluetooth capability on equipped models. Set to one of 5 selectable CCT points for Selectable White Mode.

* Dim-to-Off is only available with 0-10 V operation.

AC Input 2-Channel Tunable White LED Modules with Tri-Mode Dimming™ (TRIAC, ELV & 0-10 V)

3 - MECHANICAL SPECIFICATIONS

Specification	Notes	
Dimensions	Diameter:	65 mm (nominal 2.56 in)
	Height:	20.54 mm (nominal 0.81 in)
Light Emitting Surface (LES)	32 mm (nominal 1.26 in)	
CWM2 Weight	45 g (1.6 oz)	
Heat Sink Attachment	Front-mount, countersunk, M3 x 25 mm	
Max Case Temperature (T _c)	≤ 95 °C	

Note: See next section for details on the cable assemblies for CWM2.

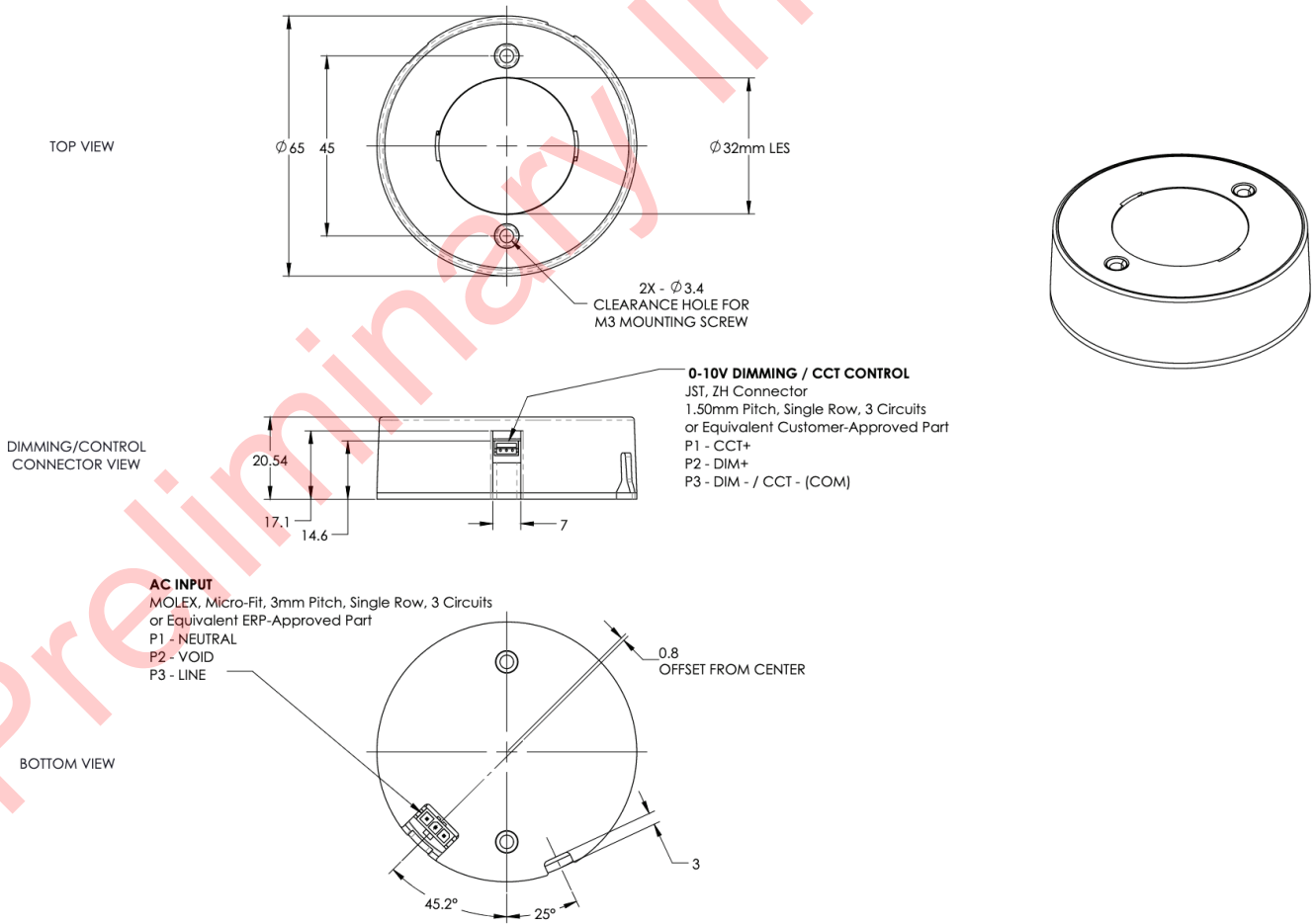

Note: All dimensions are in millimeters.

AC Input 2-Channel Tunable White LED Modules with Tri-Mode Dimming™ (TRIAC, ELV & 0-10 V)

4 - CABLE ASSEMBLIES

4.1 2-Wire AC Input Power Cable Assemblies for CWM2

For North America

Part Number: AC-CWM2-NA
Length: 400 mm (nominal 16 in.)

Item No.	Part No.	Wire Description	Wire Color	Input	Qty.
3	UL 1430	Wire Stranded Tinned 18 AWG (Pin-1)	White	Neutral	1
4	UL 1430	Wire Stranded Tinned 18 AWG (Pin-3)	Black	Line	1

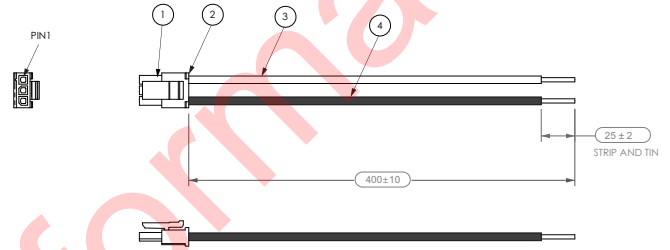

For North America, with Quick Disconnect

Part Number: AC-CWM2-NAQD
Length: 413 mm (nominal 16.25 in.)

Item No.	Part No.	Description	Color	Input	Qty.
3	UL 1430	Wire Stranded Tinned 18 AWG (Pin-1)	White	Neutral	1
4	UL 1430	Wire Stranded Tinned 18 AWG (Pin-3)	Black	Line	1
5	SA2-10, SINGLE	NBC ELECTRONIC 2-Pin Connector	Orange	N/A	1

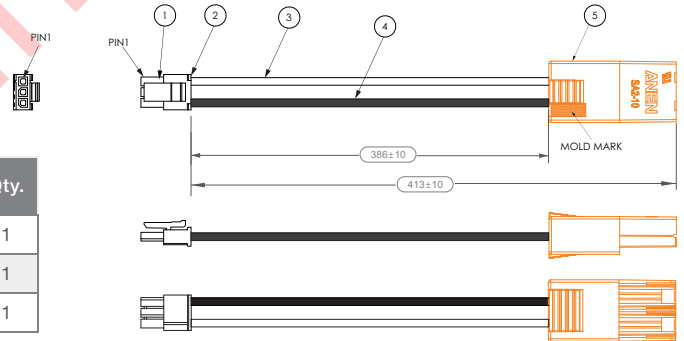

General Specifications for Power Cable Assemblies

Item No.	Part No.	Manufacturer	Description	Quantity
1	3016H-1*03	ECI	Connector 3-Pin	1
2	3016P-L	ECI	Connector Crimp	2

Note: All dimensions are in millimeters.

AC Input 2-Channel Tunable White LED Modules with Tri-Mode Dimming™ (TRIAC, ELV & 0-10 V)

4 - CABLE ASSEMBLIES

4.2 3-wire DC Output Control Cable Assembly for CWM2

For North America

Part Number: DC-CWM2-NA
Length: 400 mm (nominal 16 in.)

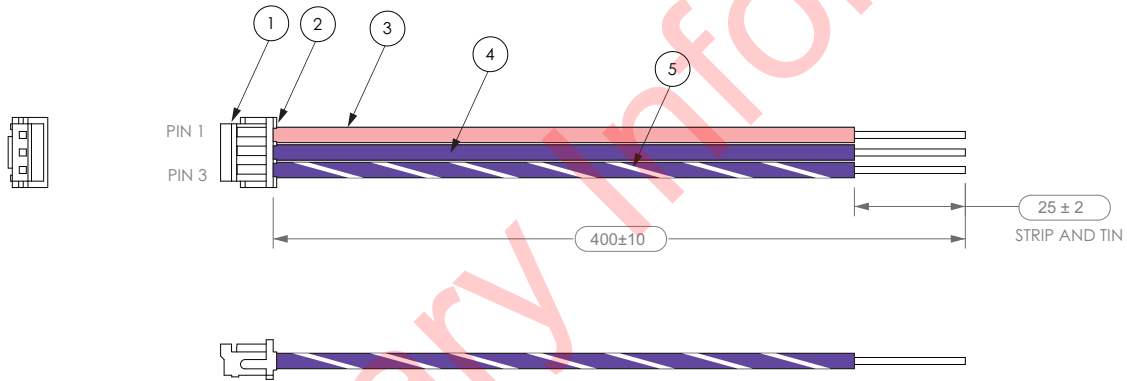

Item Number	Part Number	Manufacturer	Description	Input	Quantity
1	SCD1502AZ-103032	Foxeco	Connector 3-Pin	N/A	1
2	SCD1502AZ-000000	Foxeco	Connector Crimp	N/A	3
3	UL 1061	Any	Wire Stranded Tinned 24 AWG Pink (Pin 1)	Dim (-) / CCT (-) Common	1
4	UL 1061	Any	Wire Stranded Tinned 24 AWG Violet (Pin 2)	Dim (+)	1
5	UL 1061	Any	Wire Stranded Tinned 24 AWG Violet with White Spiral (Pin 3)	CCT (+)	1

Note: All dimensions are in millimeters.

AC Input 2-Channel Tunable White LED Modules with Tri-Mode Dimming™ (TRIAC, ELV & 0-10 V)

5 - HEAT SINKING RECOMMENDATIONS

The CWM2 requires an external heat sink in order to ensure proper operating temperature of the LEDs. The CWM2 has a conductive aluminum base and an efficient thermal path to the LED array. These features promote efficient thermal management and allow for a simple heat sink design in most applications. Below are several available heat sinks showing substrate temperature at different Lumen outputs. The below list is not exhaustive, and serves as a list of recommendations.

The light engine is designed to be installed in a variety of lighting fixtures (Conduction from the CWM2 to the heatsink and then Convection to ambient air). Solid contact between the base of the light engine and the heat sink is important, as well as a thermally conductive material of at least 10 W/(m²K) for full output operation to ensure efficient transfer of heat. For reliability qualification, an extruded heat sink was used for internal testing.

In many fixtures, the air flow to the heat sinks is obstructed or the heat sink is in an enclosed container with no path to reject heat. The thermal design of the fixture must be optimized, so that the case temperature (T_c) measured at the base of the engine remains at its recommended temperature.

IMPORTANT: Most heat sinks are qualified in “free air” at an approximate ambient temperature of 25 °C. If the CWM2 is installed in an insulated can fixture (IC Can), the light engine may exceed the recommended operating temperature. The heat sink must be evaluated and temperature tested in the fixture at applicable ambient temperatures for the desired application.

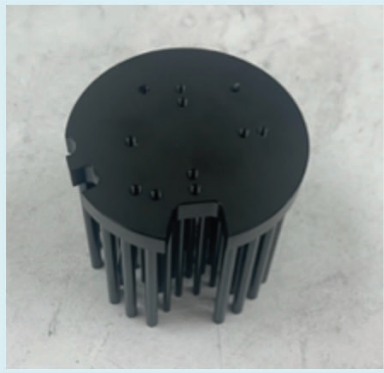
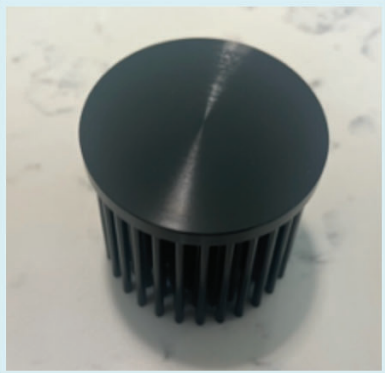
Manufacturer Model	Mechatronix GH36D 9980-B	Mechatronix LPF67A68-8-B	Mechatronix LPF70A50-5-B
			
	GH36D 9980-B, 120 Vac, Rev. X04, 4000K CCT	LPF67A68-8-B, 120 Vac, Rev. X04, 4000K CCT	LPF70A50-5-B, 120 Vac, Rev. X04, 4000K CCT
Light Engine Output (Lumen)	Ts at Ta of 40 °C		Ts at Ta of 40 °C
850			
1000			69.1
1250			74.5
1500		72.8	79.9
2000		82.5	91.5
2500 (Max)	64.9	85.3	97.4

AC Input 2-Channel Tunable White LED Modules with Tri-Mode Dimming™ (TRIAC, ELV & 0-10 V)

6 - TEMPERATURE MEASUREMENT POINTS

The thermal management characteristics of the heat sink used with the CWM should be validated by measuring its **case temperature (T_c)**. This test should be done with the CWM installed in the fixture at ambient temperature and air flow conditions similar to the end-use installation. It is recommended that the thermal management system be designed for a $T_c < 90^\circ\text{C}$.

CWM has on-board over temperature protection (OTP) which will throttle the currents to the LED arrays starting at 95°C (T_j). The CCT at which the unit is operating will be maintained in this mode, but the output lumens will drop. This ensures that the LEDs are not subjected to abnormal temperatures.

On BLE (Premium) equipped units, the **substrate temperature (T_s)** is reported on the ERP Tunable White iOS app, and can be used during the fixture design stage to verify proper heat sinking and/or to optimize the design of the thermal management system. This will give the most reliable measurement of the LED temperature. The T_s reading should be made after the unit has reached steady state, where the temperature levels out.

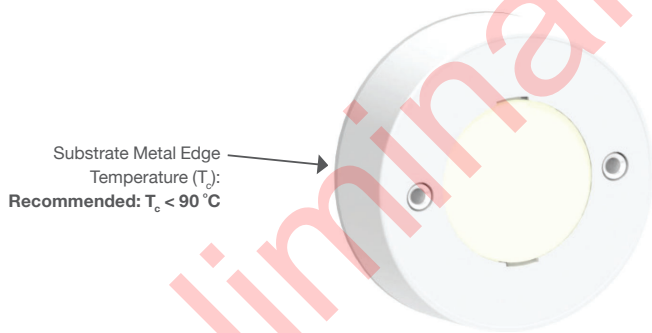

Case Temperature (T_c) Measurement Point

Note: The T_c is measured at the base of the engine.
BLE units report the temperature of the T_c .

Note: All dimensions are in millimeters.

AC Input 2-Channel Tunable White LED Modules with Tri-Mode Dimming™ (TRIAC, ELV & 0-10 V)

7 - ATTACHING COMPATIBLE CWM2 REFLECTORS (AN EXAMPLE)



NATA REFLECTOR (2-1567-M)
CUSTOM ELASTIC CONNECTOR

Placeholder
Graphic



LED REFLECTOR (F13325)
CUSTOM ELASTIC CONNECTOR

Placeholder
Graphic

Note: All dimensions are in millimeters.

AC Input 2-Channel Tunable White LED Modules with Tri-Mode Dimming™ (TRIAC, ELV & 0-10 V)

8 - CWM CONFIGURATION TOOLS

8.1 CWM Programming Tool - Description

The 'CWM Programming Tool' has the capability to configure any static CCT point from twelve pre-programmed CCT selections and two Warm Dim profiles. The CWM Programming Tool also allows installers to set the maximum light output limits to FULL, 80%, 60%, or 40% by setting a Dim-Trim, while enabling a Dim-to-Off capability and/or disabling Bluetooth LE on Premium models.

The CWM Programmer has two 4-position DIP switches, one for CCT selection and the other allowing the user to disable BLE, to enable Dim-to-Off capability, and to set a Dim-Trim. The DIP switch settings are ON position for '1' and OFF position for '0', and the value is set as a 4-bit binary code. All possible settings and corresponding switch positions are listed below.

Part Number	Description
PROG-CWM2	CWM Programming Tool with CWM2 Programming Cable
PROG-CWM2-CBL	CWM2 Programming Cable

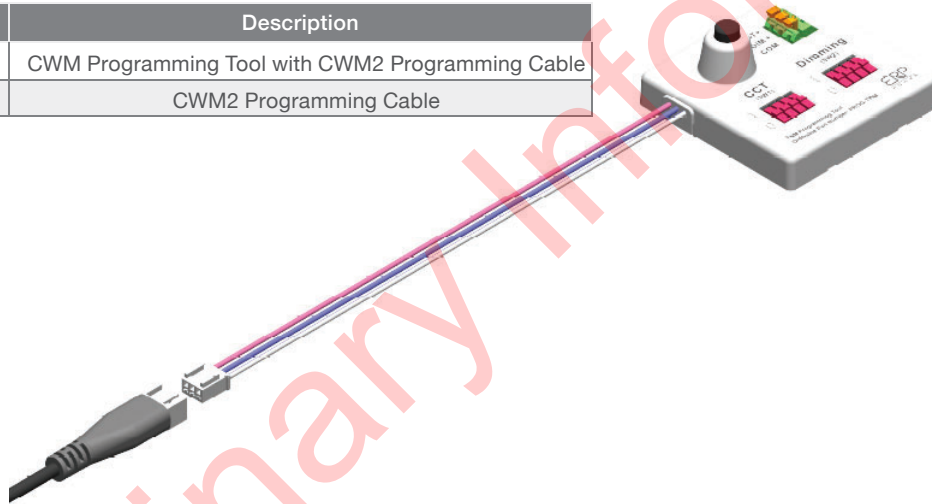

CCT DIP Switch (SW1) Selections		0 = OFF, 1 = ON			
0	FACTORY DEFAULT	0	0	0	0
1	NOT USED	0	0	0	1
2	NOT USED	0	0	1	0
3	NOT USED	0	0	1	1
4	NOT USED	0	1	0	0
5	NOT USED	0	1	0	1
6	CCT Fixed, 2750 K	0	1	1	0
7	CCT Fixed, 3000 K	0	1	1	1
8	CCT Fixed, 3500 K	1	0	0	0
9	CCT Fixed, 4000 K	1	0	0	1
10	CCT Fixed, 4500 K	1	0	1	0
11	CCT Fixed, 5000 K	1	0	1	1
12	NOT USED	1	1	0	0
13	NOT USED	1	1	0	1
14	NOT USED	1	1	1	0
15	NOT USED	1	1	1	1

Dimming DIP Switch (SW2) Selections				0 = OFF, 1 = ON			
Dim-Trim	BLE Status	Dim-to-Off					
0	Full Output		0	0	0	0	
1	80%		0	0	0	1	
2	60%		0	0	1	0	
3	40%		0	0	1	1	
4	Full Output	Dim-to-Off Enabled	0	1	0	0	
5	80%		0	1	0	1	
6	60%		0	1	1	0	
7	40%		0	1	1	1	
8	Full Output	BLE Disabled	1	0	0	0	
9	80%		1	0	0	1	
10	60%		1	0	1	0	
11	40%		1	0	1	1	
12	Full Output	BLE Disabled	1	1	0	0	
13	80%		1	1	0	1	
14	60%		1	1	1	0	
15	40%		1	1	1	1	

AC Input 2-Channel Tunable White LED Modules with Tri-Mode Dimming™ (TRIAC, ELV & 0-10 V)

8 - CWM CONFIGURATION TOOLS

8.2 CWM Programming Tool - Usage Instructions

Setting up the CWM Programming Tool (THIS ONLY NEEDS TO BE DONE ONCE):

- STEP 1.** On the 4-position DIP switch marked 'CCT (SW1)', set the ON/OFF switch combination according to one of fifteen (15) profiles listed in the "CCT DIP Switch (SW1) Selections" table on the previous page. If all the DIP switches have been set to OFF (0), the factory default will be programmed.
- STEP 2.** On the other 4-position DIP switch marked as 'Dimming (SW2)', set the lumen output limit by setting Dim-Trim at 100%, 80%, 60%, or 40%. Depending on whether Bluetooth should be disabled or if Dim-to-Off capability is needed, select from one of sixteen (16) ON/OFF switch combinations according to the "Dimming DIP Switch (SW2) Selections" table on the previous page. If all the DIP switches have been set to OFF (0), the factory default will be used, which is at full output with BLE enabled and without Dim-to-Off capability."

EXAMPLE: Fixed CCT at 3000K with Dim-Trim at 80% (2000 lm), BLE disabled, and Dim-to-Off enabled:

STEP 1. Set the CCT Selector DIP switch to #7 [0,1,1,1].

STEP 2. Set the DIMMING Selector DIP switch to #13 [1,1,0,1].

Programming Each CWM Light Engine (ONCE THE PROGRAMMING TOOL IS SET):

- STEP 1.** Remove TRIAC dimmer, if attached.
- STEP 2.** Power up (AC) a CWM light engine.
- STEP 3.** Connect the CWM Programming Tool to CWM2 (via the provided connector).
- STEP 4.** Press the commissioning button 3 times (fairly quickly in a 1.5-second timeframe).
- STEP 5.** CWM will flash 3 times in blue (indicating the program), and then CWM will be at the desired CCT and Dim-Trim.
- STEP 6.** Remove the Programming Tool from the CWM light engine within 10 seconds*.

GENERAL NOTES:

* For 10 seconds after programming is acknowledged, the unit will ignore the signals on 0–10 V Dim and CCT lines; this gives the user enough time to unplug the programmer. Not removing the Programmer in time will shift or change to the voltages that the dip switches correspond to.

After the programming is completed, the user can then connect 0–10 V dimmers without needing to power cycle the programmed unit. The CWM engine will follow commands from the connected 0–10 V sliders. The programmed CCT value is retained. Note that connecting the 0-10 V CCT dimmer forces the CWM2 into tunable white mode, as activity on the 0-10 V CCT line supercedes other commands. Once the CCT 0–10 V slider is removed and the unit is power cycled, it will resume the programmed CCT one second after startup.

As long as the Bluetooth commissioning capability was not "disabled", the ERP Tunable White iOS app is capable of overriding the programmed setpoint.

'Dim-to-Off' capability is only available using 0–10 V dimmer control.

AC Input 2-Channel Tunable White LED Modules with Tri-Mode Dimming™ (TRIAC, ELV & 0-10 V)

9 - TWO MODES OF OPERATION

CCT MODES	Static (Selectable CCT)	Tunable White
Selectable CCTs/ Ranges	2750K, 3000K, 3500K, 4000K, 4500K, 5000K, 5700K	2750 - 5000K
Default CCT	3000K	2750 - 5000K
Light Intensity Control/Dim	0-10 V or TRIAC	0-10 V or TRIAC
Mode Control with CCT 0-10 V Wires	Open: Fixed CCTs Selected "Set and Forget"	Connected to CCT 0-10 V: Dimmer Tunes CCT

AC Input 2-Channel Tunable White LED Modules with Tri-Mode Dimming™ (TRIAC, ELV & 0-10 V)

9 - TWO MODES OF OPERATION

9.1 Summary

MODES OF OPERATION SUMMARY			
	CCT Range and Presets	Controllability	Options for Setting CCT
TUNABLE WHITE	2750-5000 K	Two independent 0-10 V controllers for DIM and CCT.	<ul style="list-style-type: none"> Customize the CCT range via the ERP Tunable White iOS app by setting CCT-Trims.
SELECTABLE WHITE	3000 K (Factory Default) 2750 K, 3500 K, 4000 K, 4500 K, 5000 K	Only use DIM control (0-10 V, TRIAC, or ELV).	<ul style="list-style-type: none"> OPTION-1: Commission via ERP Tunable White iOS app, to "set and forget" to any CCT within full tunable range. OPTION-2: Select from one of five (5) pre-loaded ANSI CCT points on the CWM Programming Tool.

You may further customize by using the ERP Tunable White iOS app or by using the CWM Programming Tool to:

- Set Dim-Trim
- Enable 'Dim-to-Off'
- Disable BLE on Premium models

AC Input 2-Channel Tunable White LED Modules with Tri-Mode Dimming™ (TRIAC, ELV & 0-10 V)

9 - TWO MODES OF OPERATION

9.2 Tunable White Mode - Wiring Diagram

1. In Tunable White mode, two dimmers are needed. We recommend using two separate 0–10 V dimmers.

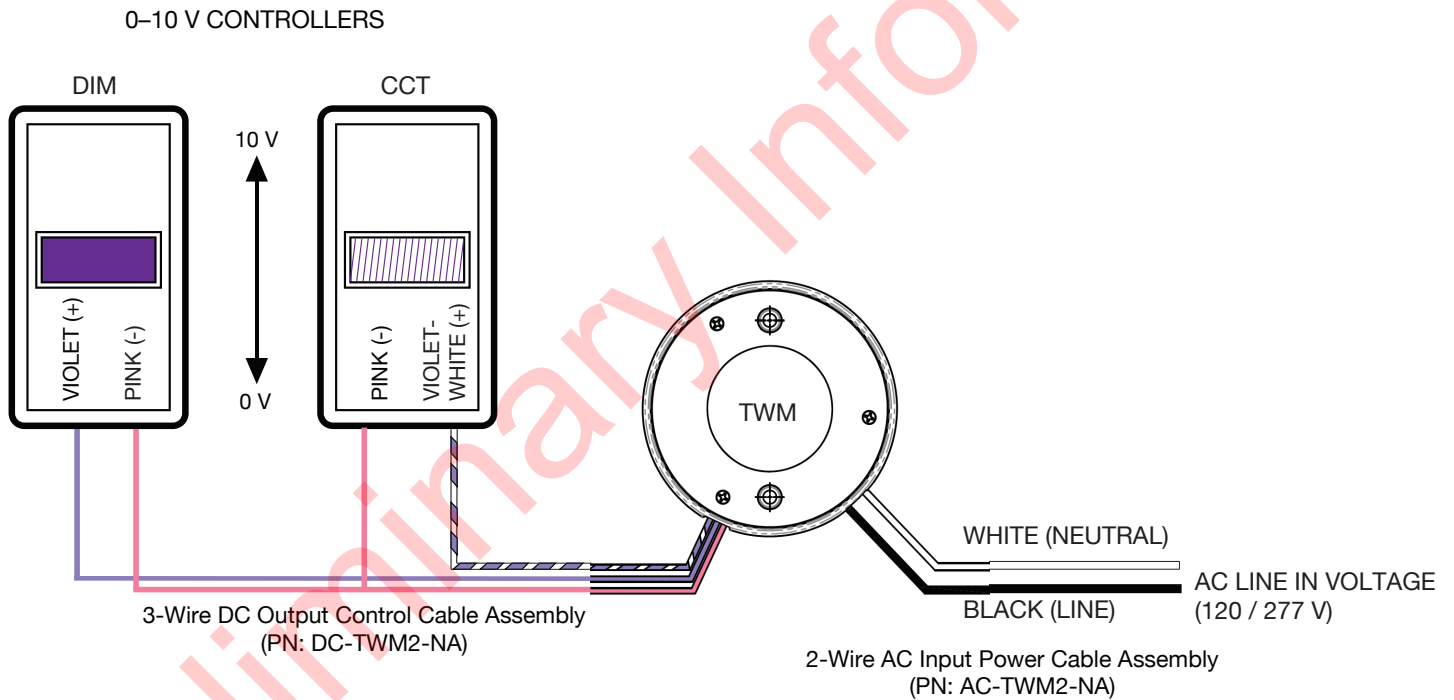

AC Input 2-Channel Tunable White LED Modules with Tri-Mode Dimming™ (TRIAC, ELV & 0-10 V)

9 - TWO MODES OF OPERATION

9.3 Selectable White Mode (Static Mode) - Wiring Diagrams

In Selectable White mode, any one of the following 0–10 V, TRIAC, or ELV Dimmer options can be used.

Use the CWM Programming Tool or the ERP Tunable White iOS app to set and forget the CCT point. Cap off the CCT+ (Violet-White) DC output control wire to prevent accidental shorting, if not being used.

TRIAC DIMMER:

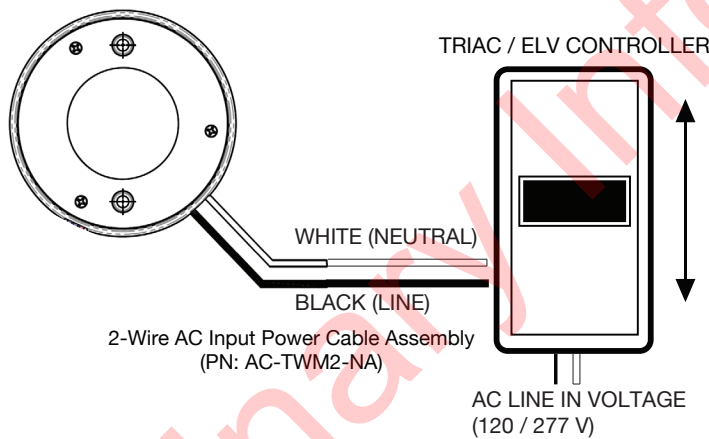

0-10 V DIMMER:

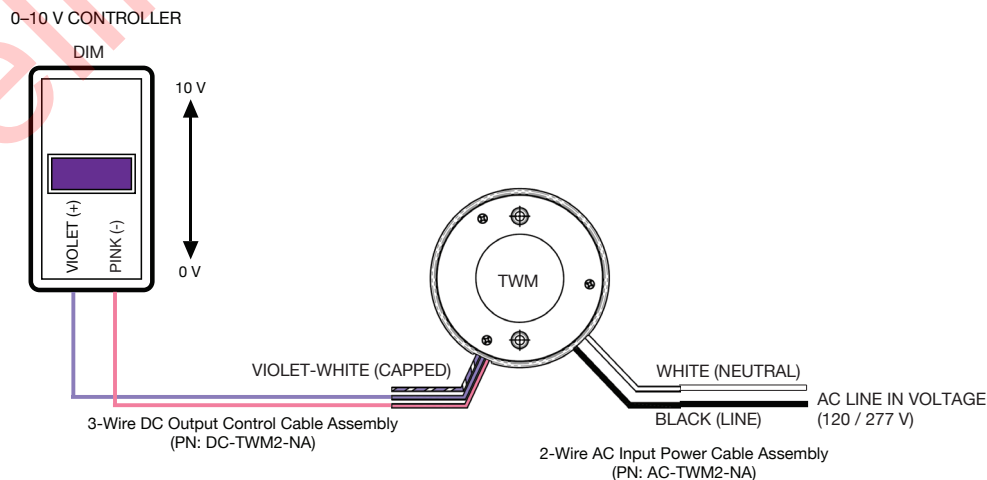

AC Input 2-Channel Tunable White LED Modules with Tri-Mode Dimming™ (TRIAC, ELV & 0-10 V)

10 - DIMMING CONTROL

The CWM operates only with 0–10 V dimmers that sink current. Developed in the 1980’s, the 0–10 V sinking current control method is adopted by the International Electrotechnical Commission (IEC) as part of its IEC Standard 60929 Annex E.

10.1 Dimming Control via 0–10 V Dimmer

The method to dim the output current of the CWM can be done via the +Dim (Violet) and -Dim (Pink) signal pins, delivering 100% to 1% of the output.

If the +Dim input is > 8 V or open circuited, the output is programmed to 100% of the rated lumens or to the maximum lumen output level trimmed by the Dim-Trim. The trim values can be set by the CWM Programming Tool (P/N: PROG-CWM2) or via the ERP Tunable White iOS app..

When +Dim input is below 1.5 V, the output is fixed to 1% of the maximum lumens, unless Dim-to-Off is enabled. If Dim-to-Off is enabled through the CWM Programming Tool or via the ERP Tunable White iOS app, the light will turn off when the +Dim input becomes below 0.7 V. As the unit detects +Dim input above 0.9 V, the light will be back to 1% of the maximum set lumens. When not used, the +Dim (purple) wire should be individually capped to prevent accidental shorting.

The maximum source current (flowing from the driver to the 0–10 V dimmer) supplied by the +Dim signal pin is ≤ 150 uA. The tolerance of the output current while being dimmed shall be +/-8% typical until down to 1.5 V.

0–10 V Dimming Protocol

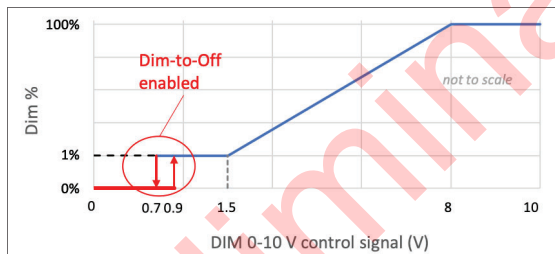

Compatible 0–10 V Dimmers for DIM Control

Manufacturer	Series	Part Number
Lutron	Nova	NFTV
Lutron	Diva	DVTV
Lutron	Diva	DVSTV
Leviton	Illumatech	1P710-DL

AC Input 2-Channel Tunable White LED Modules with Tri-Mode Dimming™ (TRIAC, ELV & 0-10 V)

10 - DIMMING CONTROL

10.2 CCT Control via 0–10 V Dimmer

The method to control the CCT is done via the +CCT (Violet-White) and -Dim (Pink) signal pins. The -DIM and -CCT share the same common. Using the ERP Tunable White iOS app, a user can define the tunable CCT range by specifying a maximum and a minimum CCT. Adjust the 0–10 V CCT dimmer DC inputs to be between 0.6 V and 9 V.

If the CCT input is > 8 V or open circuited, the output is at the maximum CCT. The CCT linearly reduces until 0.7 V and remains at the same CCT value until 0.3 V. We recommend using a linear 0–10 V controller between 0.7 V and 8 V for the best result.

When not used, the +CCT (Violet-White) should be individually capped to prevent accidental shorting.

0–10 V CCT Protocol

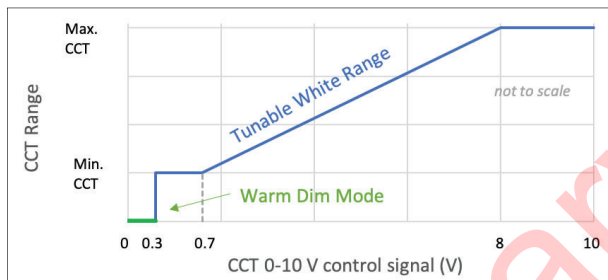

Compatible 0–10 V Dimmers for CCT Control

Manufacturer	Series	Part Number
Lutron	Diva	DVSTV

AC Input 2-Channel Tunable White LED Modules with Tri-Mode Dimming™ (TRIAC, ELV & 0-10 V)

10 - DIMMING CONTROL

10.3 TRIAC/ELV Dimming Protocol

When CWM light engines are coupled with an approved TRIAC/ELV-based phase-cut dimmer, the main processor is used to control dimming status as a function of the TRIAC/ELV conduction angles. Data on the TRIAC/ELV conduction angle is supplied to the processor, which then determines appropriate actions to ensure smooth and flicker-free dimming while maintaining color accuracy across the dimming range of the driver for all CCT set points (including Warm Dim). Both leading edge and trailing edge TRIAC/ELV dimmers can be used with tight control of the minimum and maximum lumens.

The CCT can still be controlled independently by using a 0–10 V controller or by Bluetooth commissioning via the ERP Tunable White iOS app. 100% to 1% output can be attained when using an approved TRIAC/ELV phase-cut dimmer. Maximum programmed output (100%) is reached when the phase-cut dimmer is conducting for at least 140°. Minimum programmed output (1%) is reached when the phase-cut dimmer is conducting for 45° or less.

The minimum conduction angle necessary (to ensure that the CWM light engine will always turn on and start up) is 45°.

NOTE: Changes to the 0–10 V CCT control are ignored while actively moving the TRIAC/ELV dimmer slider up and down. 0–10 V CCT control is resumed once the TRIAC/ELV dimmer has stabilized.

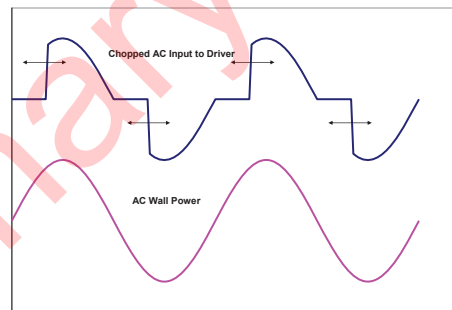

Compatible TRIAC/ELV dimmers

Manufacturer	Model
Lutron	MACL-153M
Lutron	RRD-10ND
Lutron	MRF2S-6CL
Lutron	SCL-153P
Lutron	DVCL-153P
Lutron	DVCL-253P
Lutron	TGCL-153P
Lutron	SF-10P
Lutron	LGCL-153P
Lutron	RRD-6NA
Lutron	PD-5NE
Lutron	MAELV600
Lutron	NTELV-600

Manufacturer	Model
Leviton	IPL06-ILZ
Leviton	VPI06
Leviton	IPE04
Leviton	VPE06

AC Input 2-Channel Tunable White LED Modules with Tri-Mode Dimming™ (TRIAC, ELV & 0-10 V)

USA Headquarters

Tel: +1-805-517-1300
Fax: +1-805-517-1411
2625 Townsgate Rd, Suite 106
Westlake Village, CA 91361z, USA

CHINA Operations

Tel: +86-756-6266298
Fax: +86-756-6266299
No. 8 Pingdong Road 2
Zhuhai, Guangdong, China 519060

ERP Power, LLC (ERP) reserves the right to make changes without further notice to any products herein. ERP makes no warranty, representation or guarantee regarding the suitability of its products for any particular purpose, nor does ERP assume any liability arising out of the application or use of any product or circuit, and specifically disclaims any and all liability, including without limitation special, consequential or incidental damages. "Typical" parameters which may be provided in ERP data sheets and/or specifications can and do vary in different applications and actual performance may vary over time. All operating parameters, including "Typicals" must be validated for each customer application by customer's technical experts. ERP does not convey any license under its patent rights nor the rights of others. ERP products are not designed, intended, or authorized for use as components in systems intended for surgical implant into the body, or other applications intended to support or sustain life, or for any other application in which the failure of the ERP product could create a situation where personal injury or death may occur. Should Buyer purchase or use ERP products for any such unintended or unauthorized application, Buyer shall indemnify and hold ERP and its officers, employees, subsidiaries, affiliates, and distributors harmless against all claims, costs, damages, and expenses, and reasonable attorney fees arising out of, directly or indirectly, any claim of personal injury or death associated with such unintended or unauthorized use, even if such claim alleges that ERP was negligent regarding the design or manufacture of the part. ERP is an Equal Opportunity/Affirmative Action Employer. This literature is subject to all applicable copyright laws and is not for resale in any manner.